

# TX-2860SW25A-3055V39-02H90

## PRODUCT SPECIFICATION

### Features:

- ◆ Excellent transiting heat from LED chip operating under 1900mA.
- ◆ Provide uniform cross distribution of positive white and warm white dual color scheme, mixed pure.
- ◆ High luminous output.
- ◆ No UV.
- ◆ Encapsulated materials are environmentally certified and meet environmental requirements.

### Chip Material:

- ◆ GaInN

### Emitting Color:

- ◆ White
- ◆ Warm white

### Applications:

- ◆ Commercial lighting
- ◆ General Lighting

**Package Dimensions:**

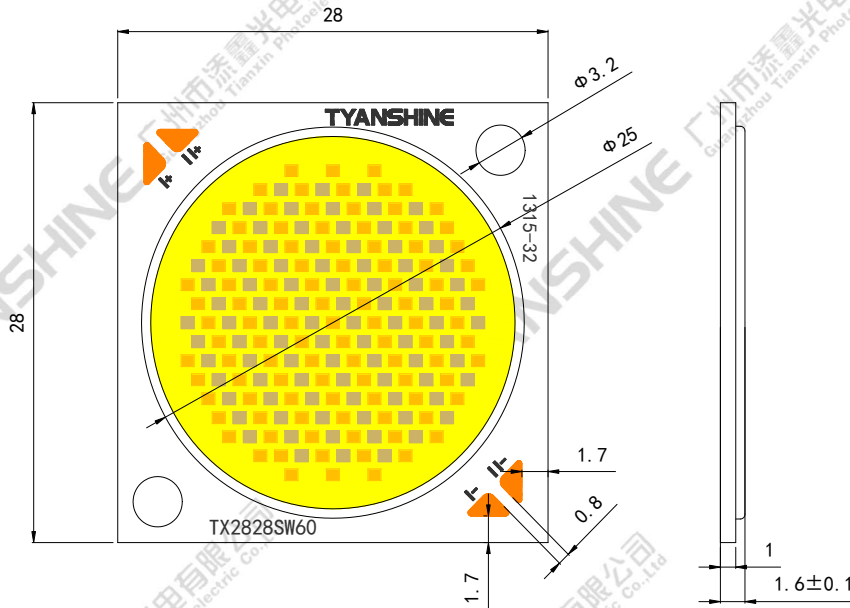

I: Warm White II: White

**Notes:**

- 1. All dimensions are in millimeters .
- 2. Tolerances unless otherwise mentioned are  $\pm 0.25\text{mm}$  .

**Code Formats:**

TX-2860SW25A-3055V39-02H90

TX	—	28	60	SW	25	A	—	3055	V39	—	02	H90
TYANSHINE	—	series	watt typ	performance	LES	texture	—	CCT	VOLTs	—	BOM	Ra

<b>Absolute Maximum Ratings</b>			
<b>Parameter</b>	<b>Symbol</b>	<b>Ratings</b>	<b>Unit</b>
Forward Current	IF	1900	mA
Reverse Voltage	VR	Not designed for reverse operation	V
Power Dissipation	PD	S	70
		W	70
		S+W	70
Junction Temperature	Tj	S	135
		W	135
Case Temperature (C)	Tc	85	°C
Electrostatic Discharge Threshold (ESD)	ESD	2000	V
Storage Temperature	Tstg	-30~+100	°C
Operation Temperature	Topr	-30~+80	

**Notes:**

- Specifications are subject to change without notice.
- The data on this specification is for reference only and the actual data is in accordance with the acknowledgment.
- Precautions for ESD:  
 STATIC SHIELD Electricity and surge damages the LED. It is recommended to use a wrist band or anti-electrostatic glove when handling the LED. All devices, equipment and machinery must be properly grounded.

**Electrical Optical Characteristics (Tc=25°C)**

Parameter	Symbol	Condition	Emitting color	Min.	Typ.	Max.	Units
Luminous Flux	$\phi_v$	If=1600mA	S	—	5400	—	lm
			W	—	6400	—	
Forward Voltage	$V_f$		S	35	37	39	V
			W	35	37	39	
Correlated Colour Temperature	CCT		S	—	3000	—	K
			W	—	5500	—	
Viewing Angle at 50% IV	$2\theta_{1/2}$		S	—	115	—	Deg
			W	—	115	—	
Reverse Current	$I_R$		—	—	—	—	$\mu A$
Thermal Resistance Junction to Case	$R\theta_{J-C}$		S	—	0.25	—	K/W
		W	—	0.25	—		
Temperature Coefficient of Voltage	$V\Delta F/T$	S	—	-15.5	—	mV/°C	
		W	—	-15.5	—		
Color Rendering Index	Ra	S	—	90	—	—	
		W	—	90	—		

**Notes:**

- 1.Luminous intensity is measured with a light sensor and filter combination that approximates the CIE eye-response curve.
2. $\theta_{1/2}$  is the off-axis angle at which the luminous intensity is half the axial luminous intensity.
- 3.Luminous flux measurement tolerance:±15%.
- 4.Forward voltage measurement tolerance:±3%.
- 5.Ra measurement tolerance: ±2.

## Typical Electrical/Optical Characteristics Curves

(25°C Ambient Temperature Unless Otherwise Noted)

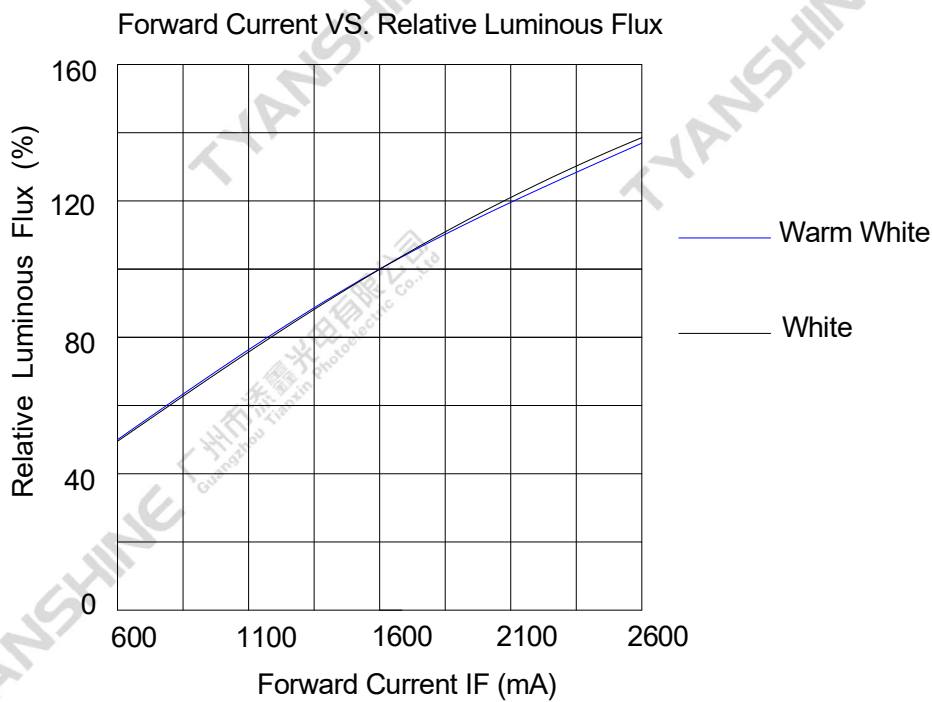
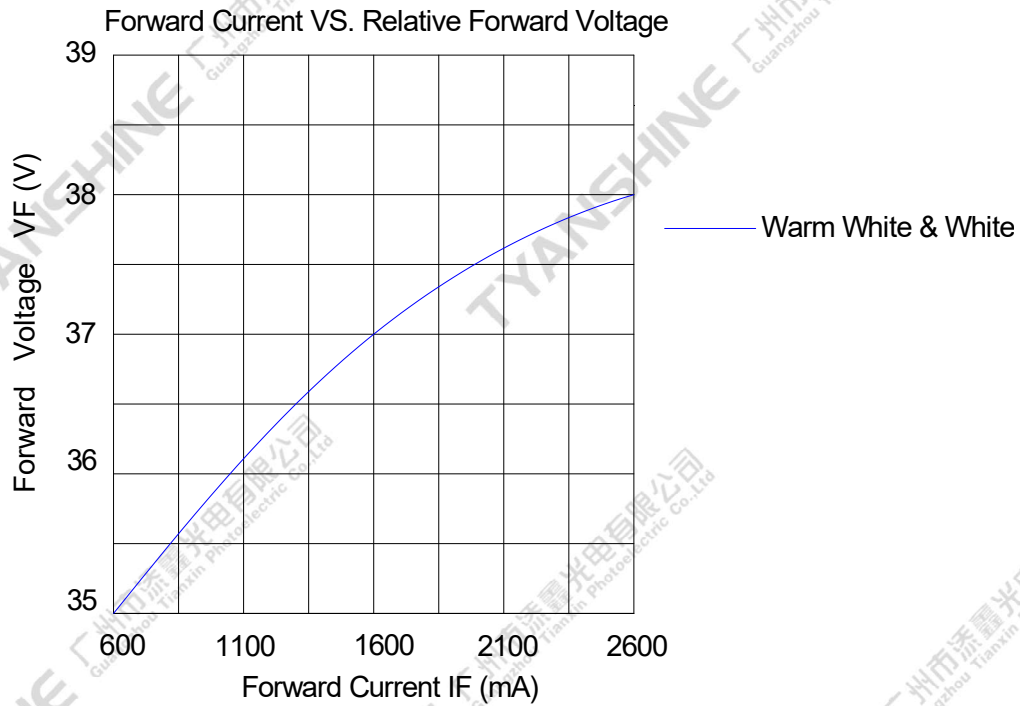

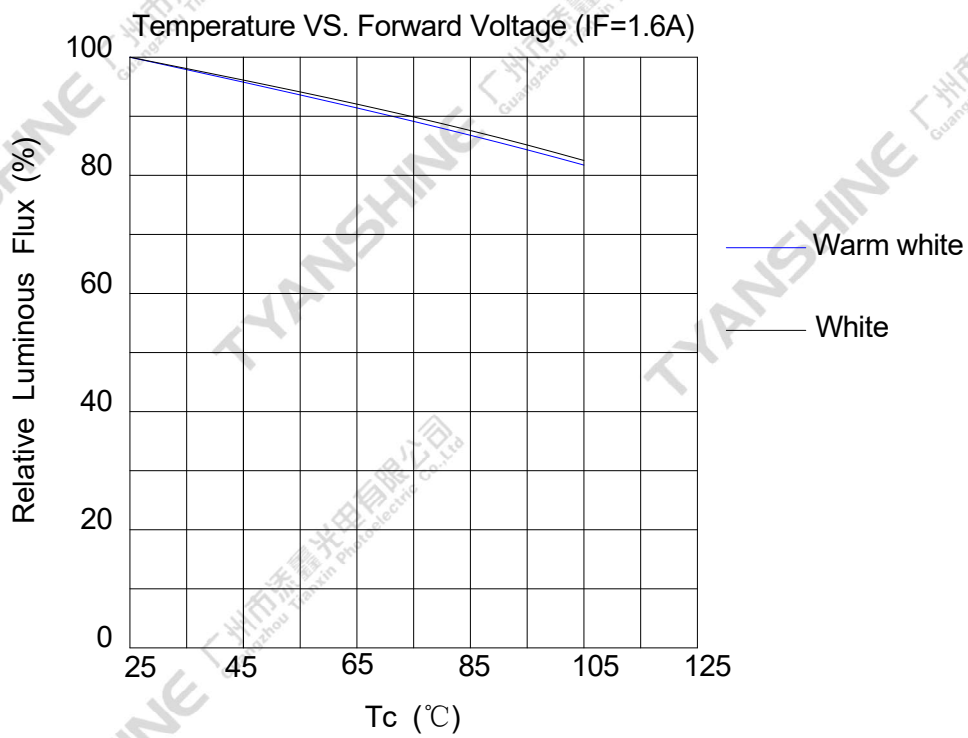
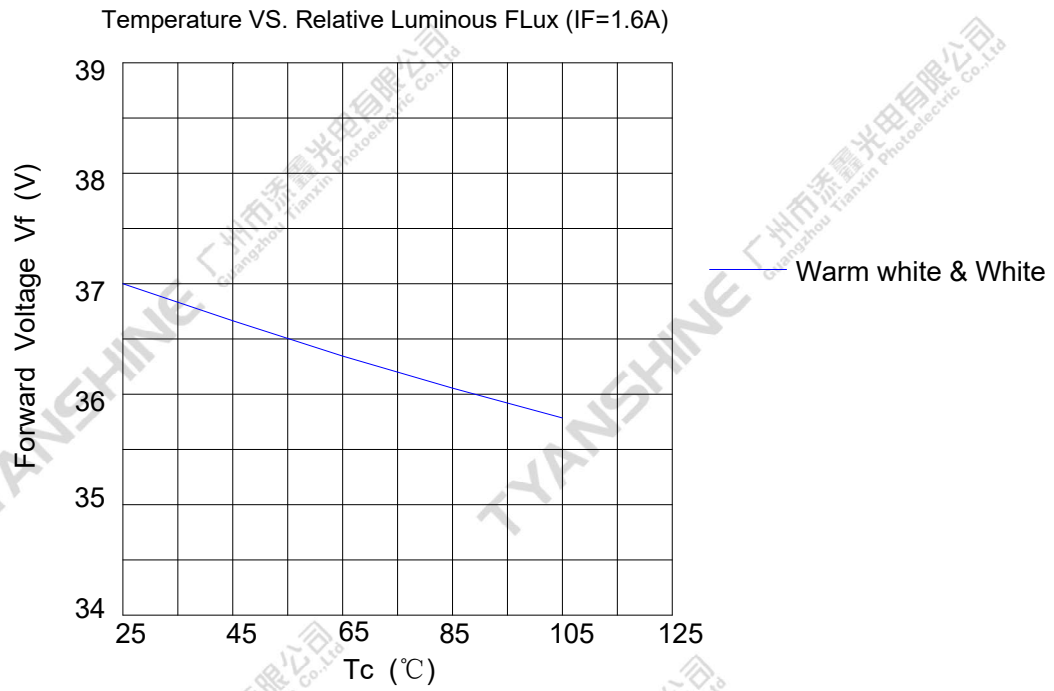

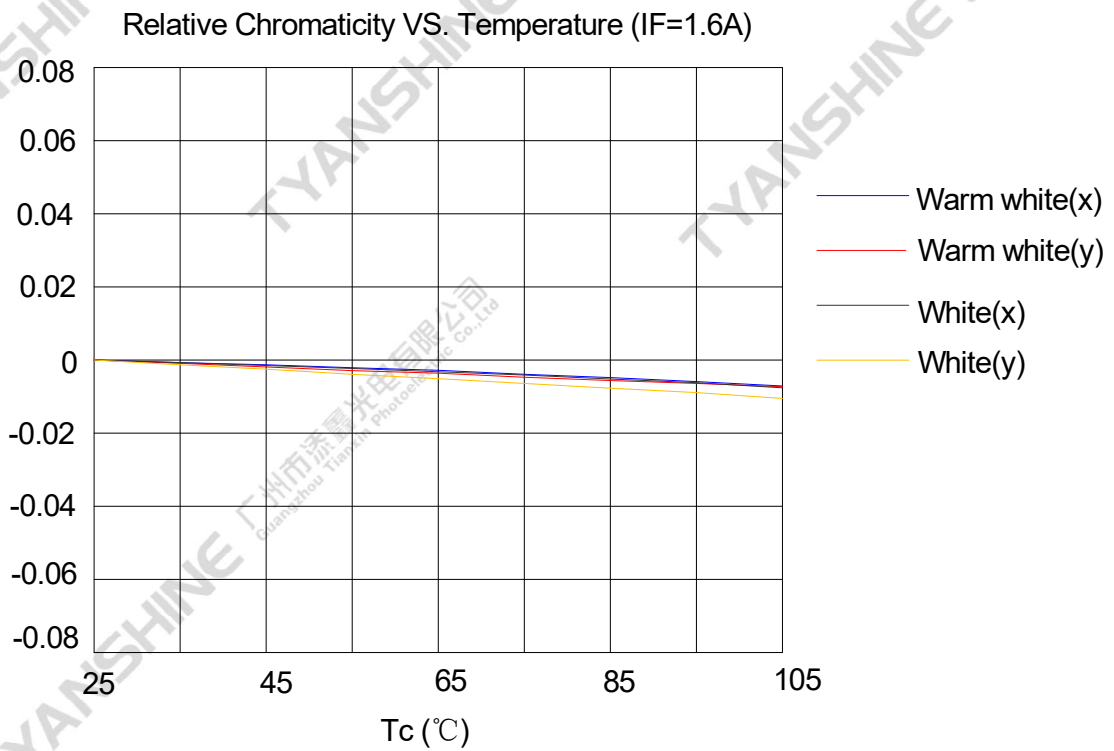
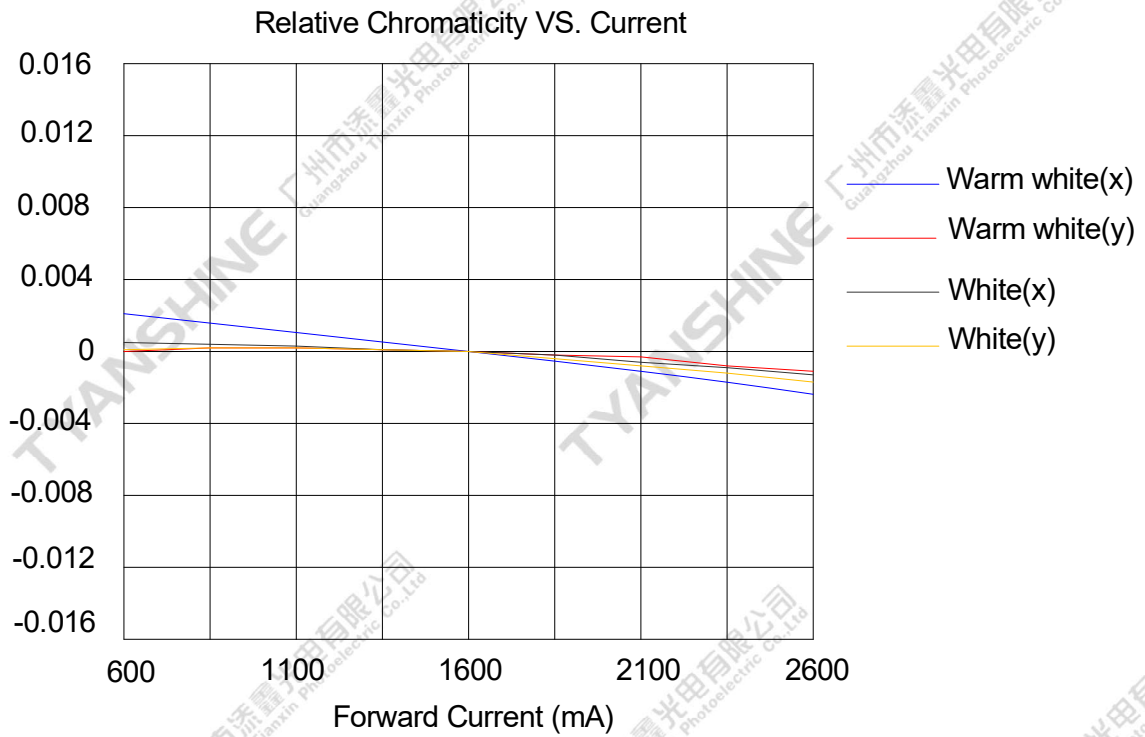

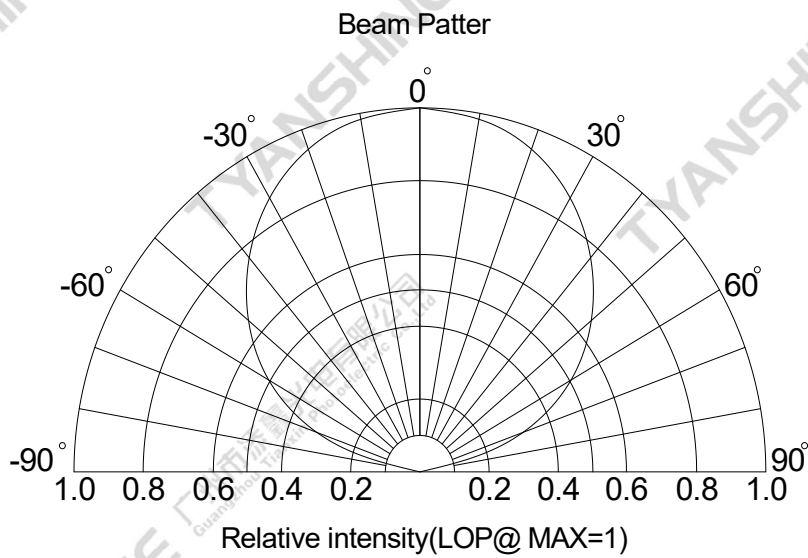
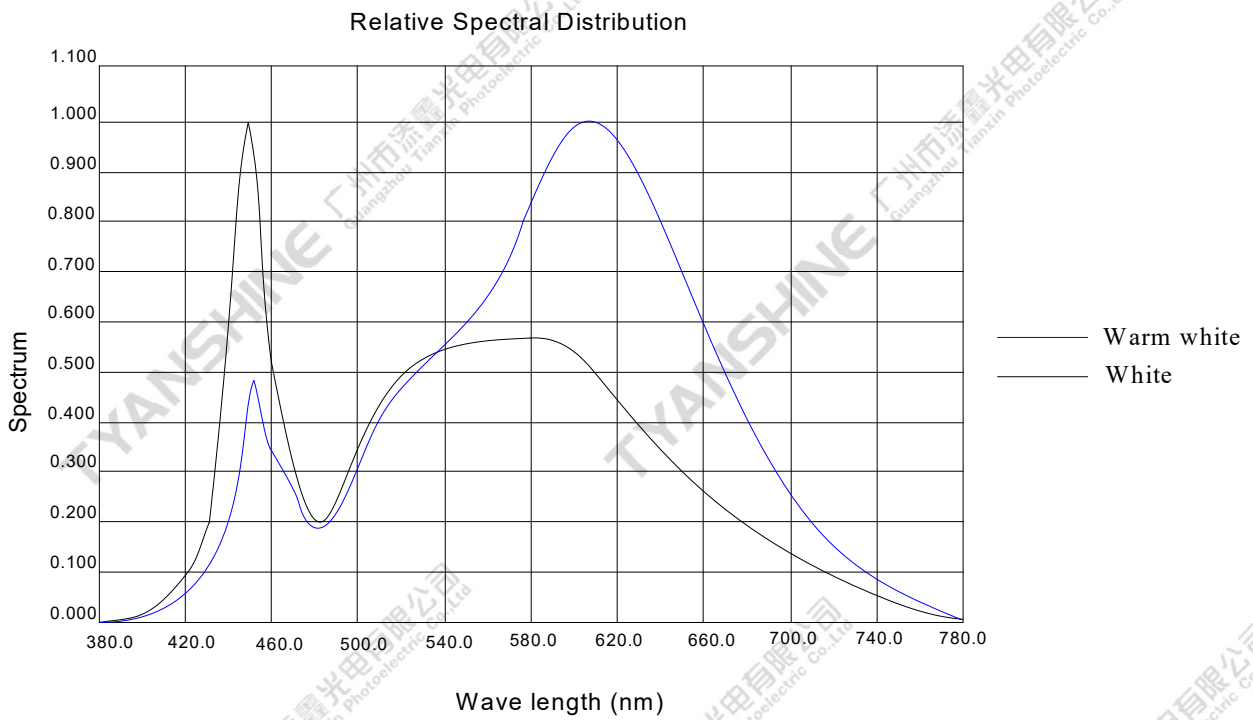

**Notes:**

1.  $2\theta \ 1/2$  is the off axis angle from lamp centerline where the luminous intensity is 1/2 of the peak value.
2. View angle tolerance is  $\pm 5^\circ$ .



Chromaticity Coordinates (Condition: IF=1600mA, Tc=25°C)

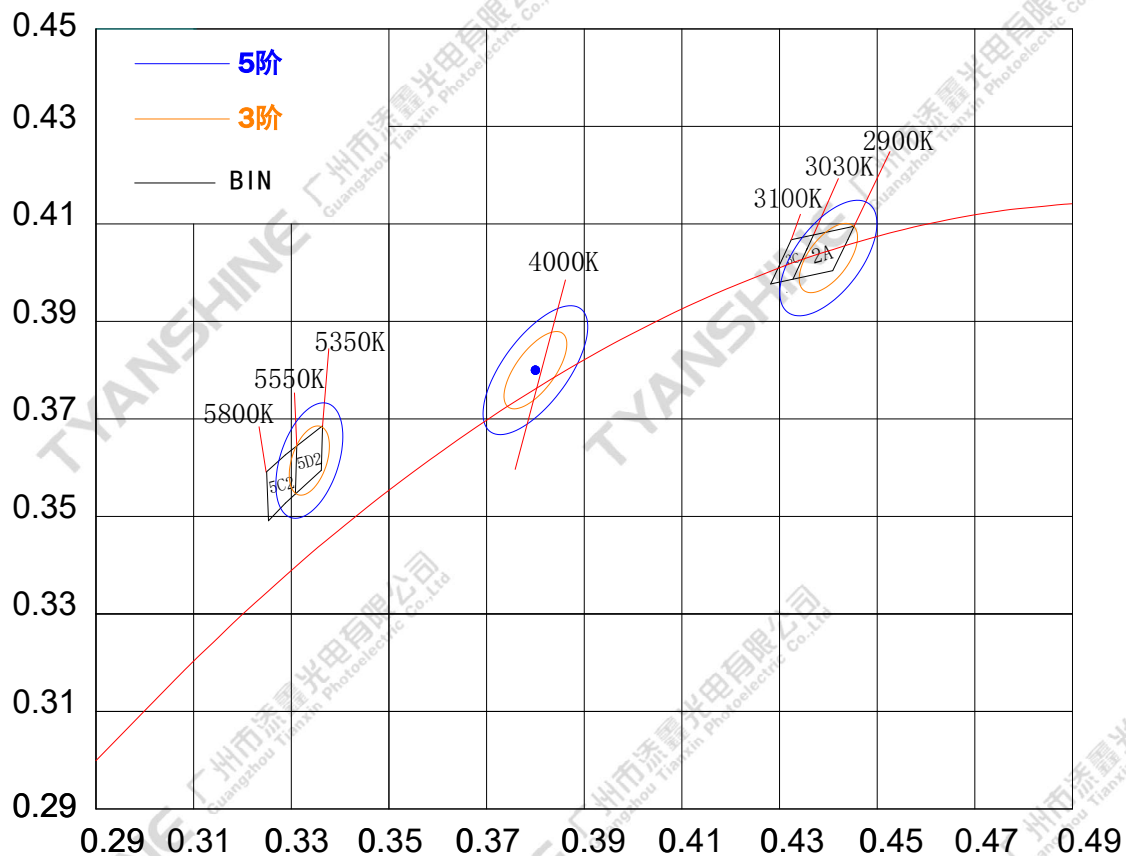

Notes:

1.chromaticity (x, y) measurements tolerance: ±0.005.

Reliability Test

Test Item	Test Condition
Continuous Operation Test	IF=1600mA Ta=25°C ×1000hrs
Low Temperature Storage Test	-30°C × 1000 hours
High Temperature Storage Test	100 °C × 1000 hours
Moisture-proof Test	85 °C, 85 %RH for 500 hours
Thermal Shock Test	-40 °C × 15 minutes – 125 °C × 15 minutes, 100 cycle

**Dimensions For Cannulation And Packaging**

**Quantity:20 PCS**

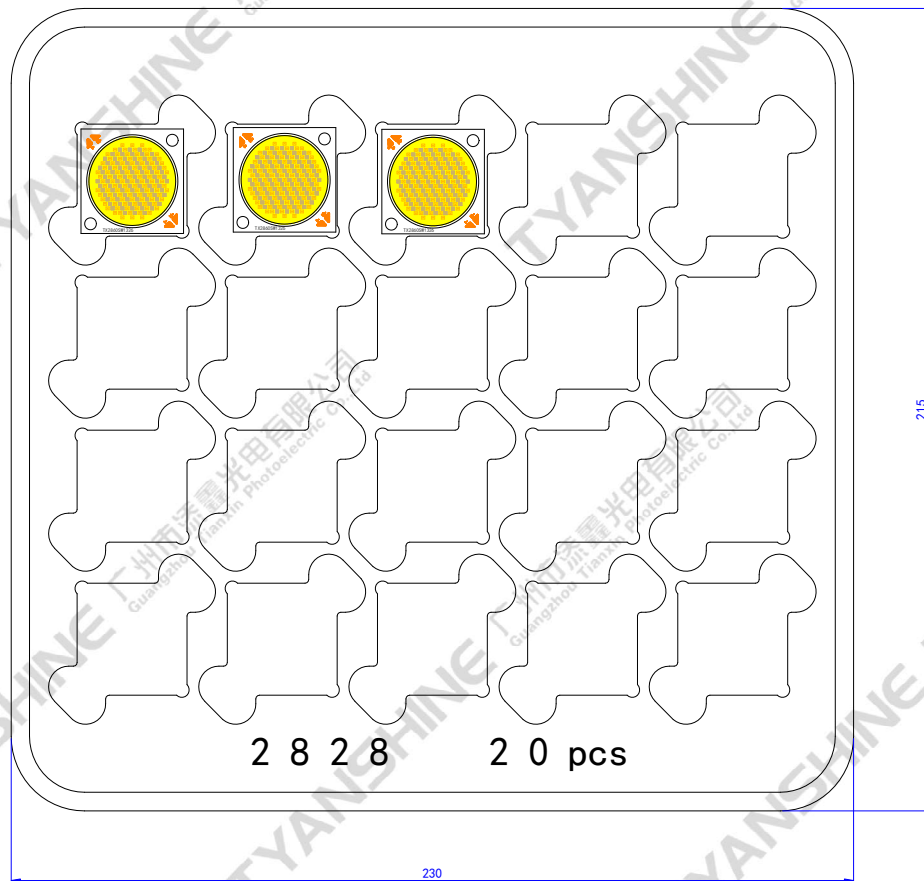

**Notes:**

1. All dimensions are in millimeters.
2. Tolerances are  $\pm 2.0$  mm unless otherwise noted.
3. The products are packaged together with silica gel, Transport, not to the weight of welding LED light-emitting area, As a result of the weight of LED light-emitting zone in the quality of, Irresponsible of the Company.

Part No.	TX-2860SW25A-3055V39-02H90	Spec No.	WKF-BF0379	Page	10 of 10
----------	----------------------------	----------	------------	------	----------