

# TX-3535RGBW10VSD1-NG4DC-01

## PRODUCT SPECIFICATION

### Features:

- ◆Excellent transiting heat from LED chip operating under 1000mA
- ◆High luminous output
- ◆No UV

### Chip Material:

- ◆Red: AlGaInP
- ◆Green: GaInN
- ◆Blue: GaInN
- ◆White: GaInN

### Emitting Color:

- ◆Red (R)
- ◆Green (G)
- ◆Blue (B)
- ◆White (W)

### Applications:

- ◆Portable flashlight
- ◆Garden lighting
- ◆General lighting

**Package Dimensions:**

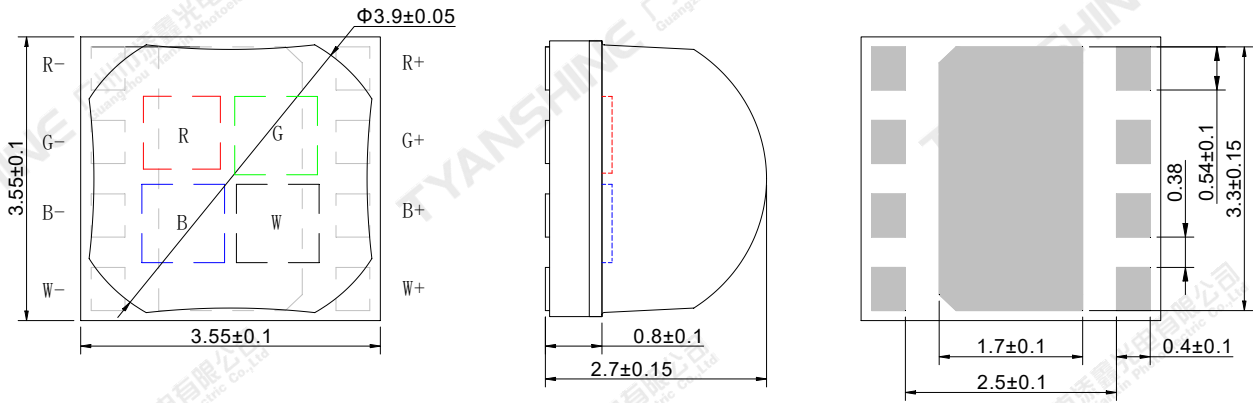

Top view

Side view

Bottom view

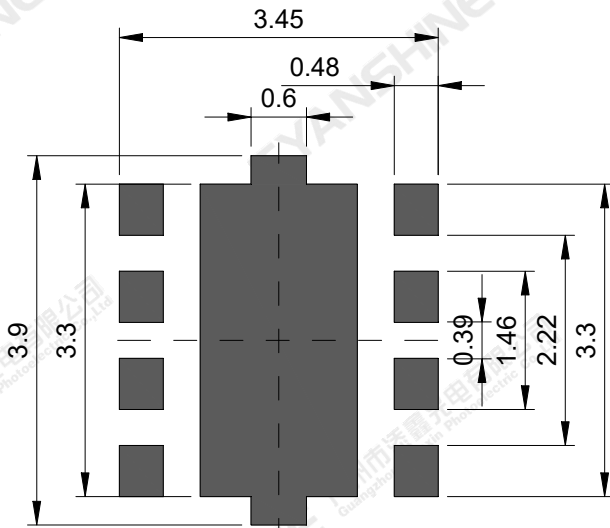

Recommended solder pad

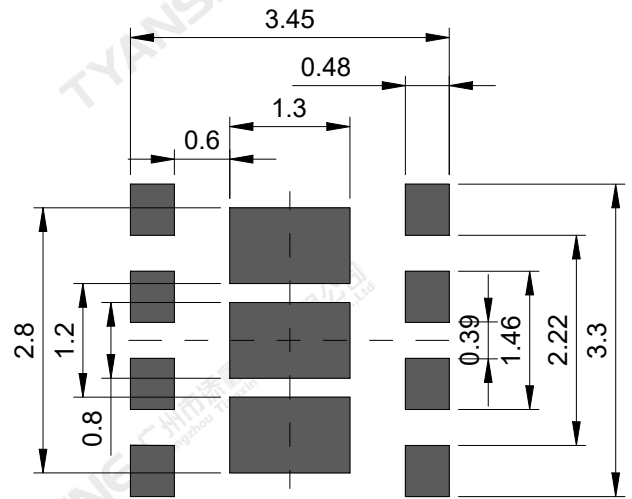

Recommended stencil pattern

**Notes:**

1. All dimensions are in millimeters .
2. Tolerances unless otherwise mentioned are  $\pm 0.1$  mm .

**Absolute Maximum Ratings (Tc=25°C)**

Parameter	Symbol	Max Ratings	Unit	
Forward Current	I <sub>F</sub>	1000	mA	
Peak Forward Current (Note 1)	I <sub>FP</sub>	R		1200
		G		1500
		B		1500
		W		1500
Reverse Voltage	V <sub>R</sub>	7	V	
Power Dissipation	P <sub>D</sub>	R	2700	mW
		G	3600	
		B	3500	
		W	3600	
Junction Temperature	T <sub>j</sub>	R	125	°C
		G	150	
		B	150	
		W	150	
Electrostatic Discharge Threshold (ESD)	ESD	2000	V	
Storage Temperature	T <sub>stg</sub>	-40~70	°C	
Operation Temperature	T <sub>opr</sub>	-30~85		

Note: 1.Pulse width ≤0.1 msec, duty ≤1/10.

**Notes:**

- Specifications are subject to change without notice.
- The data on this specification is for reference only and the actual data is in accordance with the acknowledgment.
- Precautions for ESD:  
STATIC SHIELD Electricity and surge damages the LED. It is recommended to use a wrist band or anti-electrostatic glove when handling the LED. All devices, equipment and machinery must be properly grounded.

**Electrical Optical Characteristics (Tc=25°C, IF=700mA)**

Parameter	Symbol	Emitting Color	Min.	Typ.	Max.	Units
Luminous Flux	$\phi_v$	R	110	122	135	lm
		G	210	225	245	
		B	55	60	65	
		W	240	260	280	
Correlated Colour Temperature	CCT	W	6000	6500	7000	K
Dominant Wavelength	$\lambda_d$	R	616	621	626	nm
		G	521	526	531	
		B	465	467	470	
Peak-emission Wavelength	$\lambda_p$	R	625	630	635	nm
		G	515	520	525	
		B	460	462	465	
Spectral Line Half-Width	$\Delta\lambda$	R	14	16	18	nm
		G	30	35	40	
		B	18	21	24	
		W	21	24	27	
Forward Voltage	$V_f$	R	2.0	2.4	2.7	V
		G	2.9	3.2	3.6	
		B	2.8	3.1	3.5	
		W	2.9	3.2	3.6	
Reverse Current	$I_R$	$V_R=7V$	—	—	5	$\mu A$
Viewing Angle at 50% IV	$2\theta_{1/2}$	—	—	120	—	Deg
Thermal Resistance Junction to Case	$R\theta_{J-C}$	R	—	5.3	—	K/W
		G	—	5.3	—	
		B	—	5.3	—	
		W	—	5.3	—	
Temperature Coefficient of Voltage	$V\Delta F/T$	R	—	-5.4	—	mV/°C
		G	—	-2.1	—	
		B	—	-2.0	—	
		W	—	-5.4	—	

**White light Color coordinate filing (IF=700mA)**

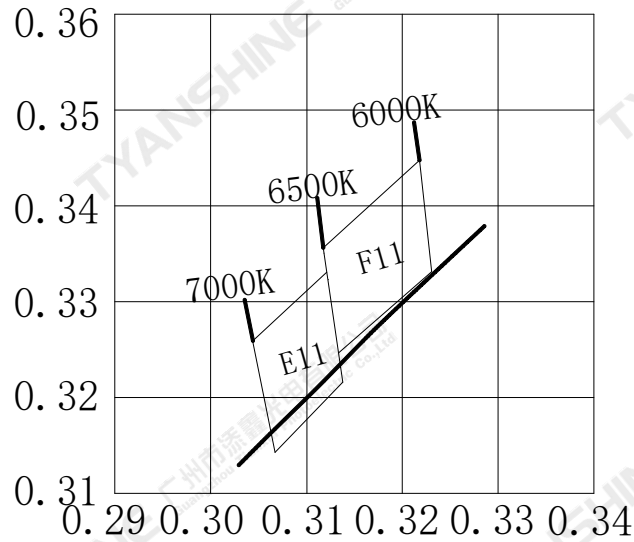

Region	CCT Range		X1	Y1	X2	Y2	X3	Y3	X4	Y4
	Min	Max								
F11	6000K	6500K	0.3134	0.3247	0.3118	0.3356	0.3218	0.3448	0.3231	0.3331
E11	6500K	7000K	0.3067	0.3143	0.3044	0.3259	0.3121	0.3331	0.3138	0.3216

**Notes:**

- 1.Luminous intensity is measured with a light sensor and filter combination that approximates the CIE eye-response curve.
2. $\theta_{1/2}$  is the off-axis angle at which the luminous intensity is half the axial luminous intensity.
- 3.Luminous flux measurement tolerance: $\pm 10\%$ .
- 4.Forward voltage measurement tolerance: $\pm 10\%V$ .
- 5.Ra measurement tolerance: $\pm 2$ .

## Typical Electrical/Optical Characteristics Curves

(25°C Ambient Temperature Unless Otherwise Noted)

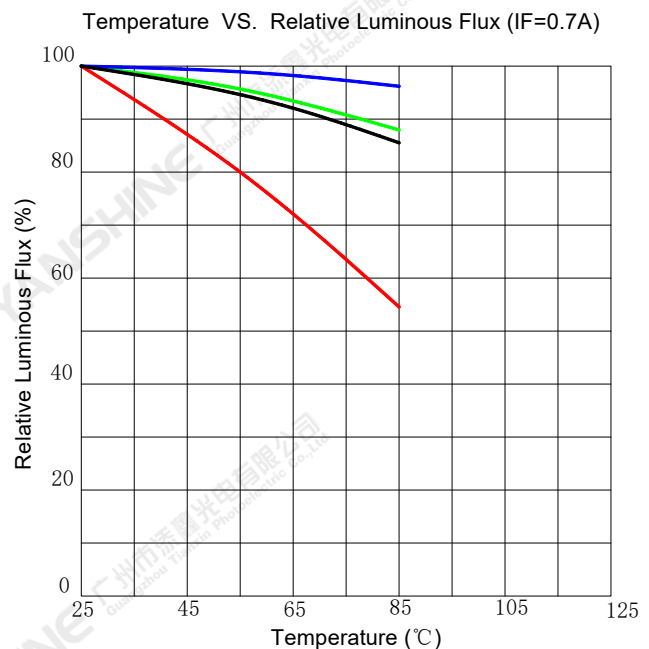
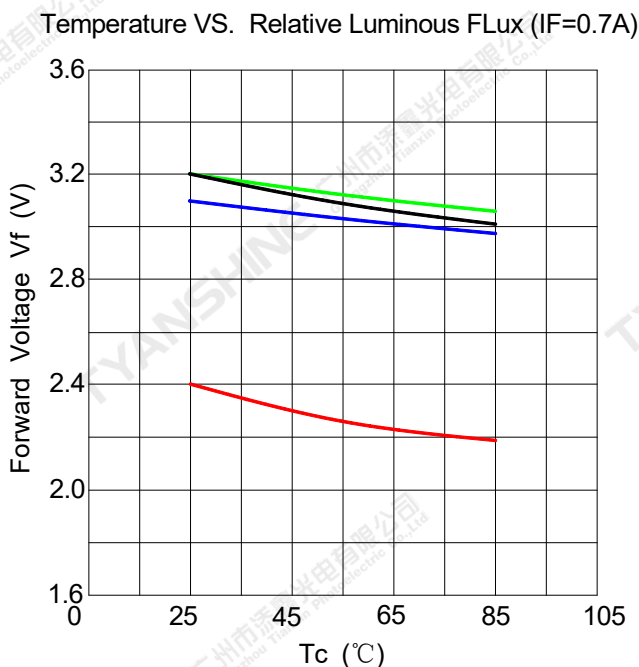
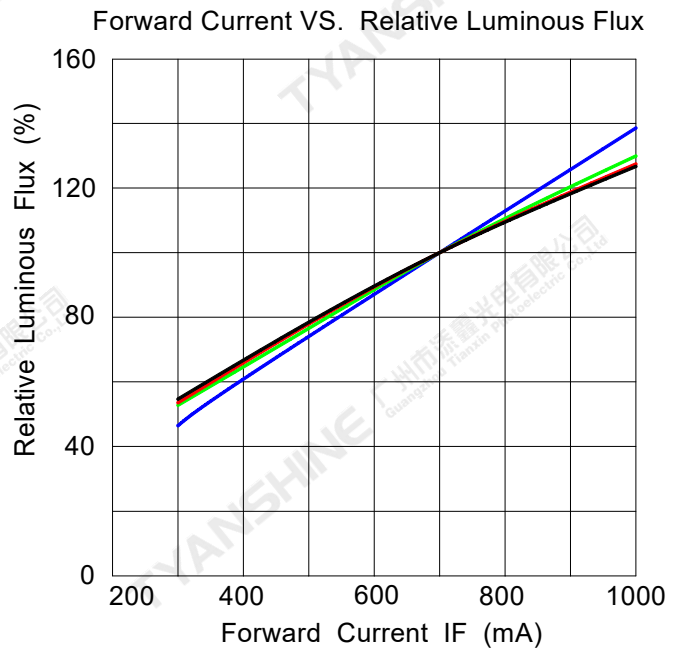
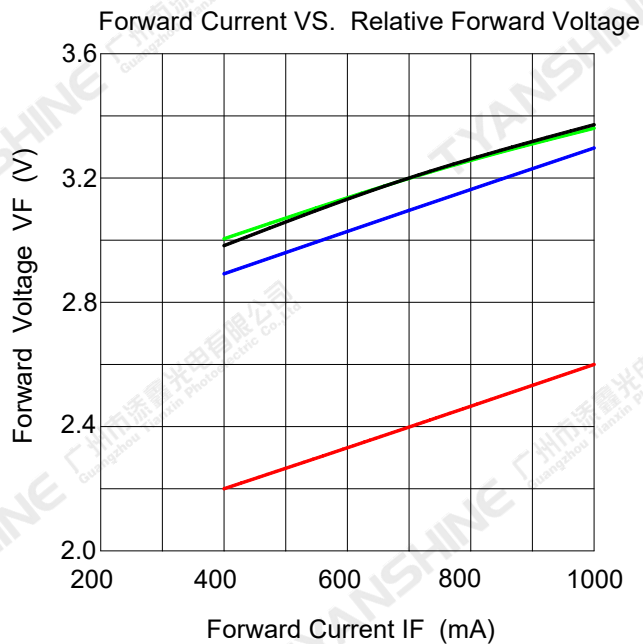

**Notes:** — Red (R) ; — Green (G) ; — Blue (B) ; — White (W) ;

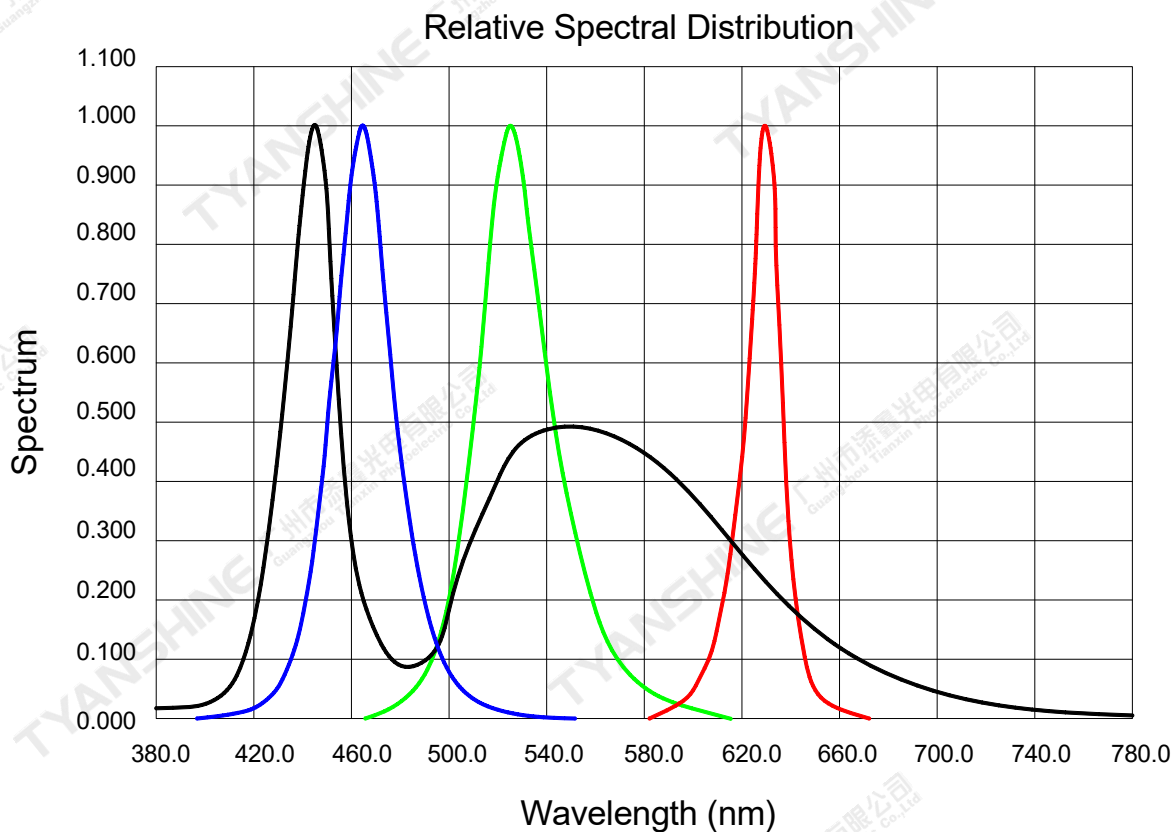
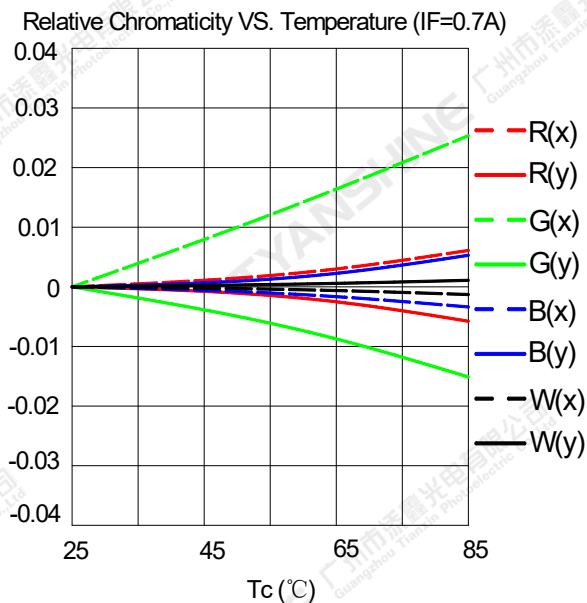
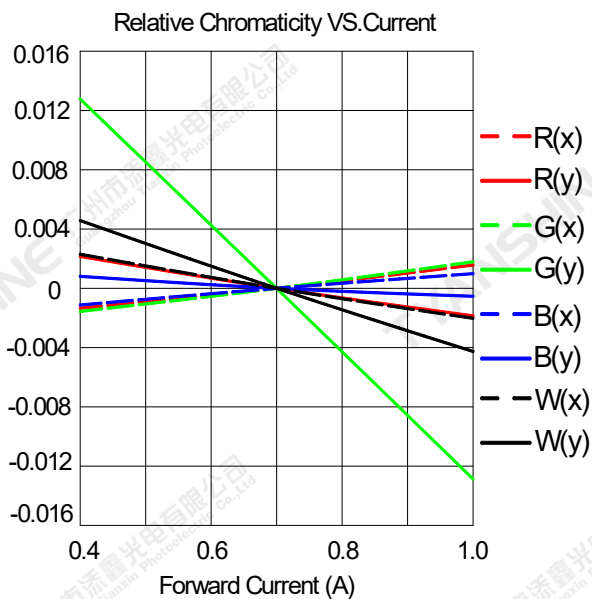

**Notes:** ■ Red (R) ; ■ Green (G) ; ■ Blue (B) ; ■ White (W) ;

**Notes:**

1.  $2\theta_{1/2}$  is the off axis angle from lamp centerline where the luminous intensity is 1/2 of the peak value.
2. View angle tolerance is  $\pm 5^\circ$ .

## Usage Precautions

### Storage Environment Condition

Temperature: 5°C ~ 30°C (41°F ~ 86°F)

Humidity: 60% RH Max.

### Soldering Condition

Use the conditions shown to the under figure.

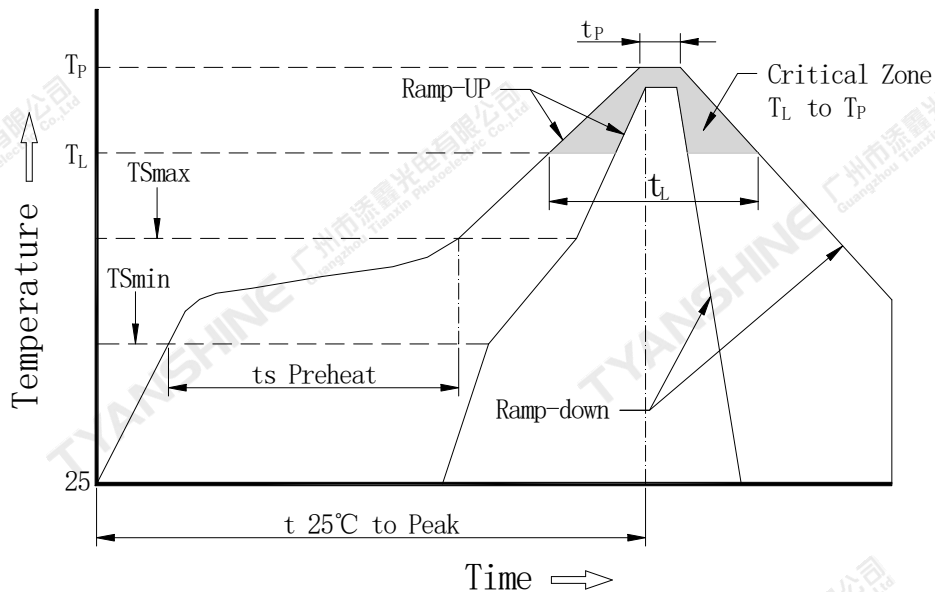

Profile Feature	Pb-Free Solderr(SnBi35Ag0.3)
Average Ramp-Up Rate (T <sub>Smax</sub> to T <sub>P</sub> )	3°C/second max.
Preheat: Temperature Min (T <sub>Smin</sub> )	130°C
Preheat: Temperature Max (T <sub>Smax</sub> )	190°C
Preheat: Time (T <sub>Smin</sub> to T <sub>Smax</sub> )	120-180 seconds
Time Maintained Above: Temperature (T <sub>L</sub> )	230°C
Time Maintained Above: Time (T <sub>L</sub> )	60-150 seconds
Peak/Classification Temperature (T <sub>P</sub> )	255°C
Time Within 5°C of Actual Peak Temperature (T <sub>P</sub> )	10-35seconds
Ramp-Down Rate	5°C/second max.
Time 25°C to Peak Temperature	7 minutes max.

### Note:

All temperatures refer to topside of the package, measured on the package body surface.



**Dimensions For Cannulation And Packaging**

**Quantity: 1000PCS**

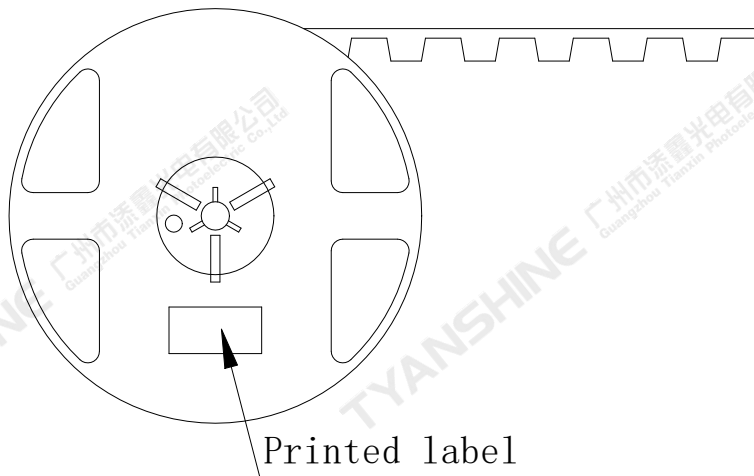
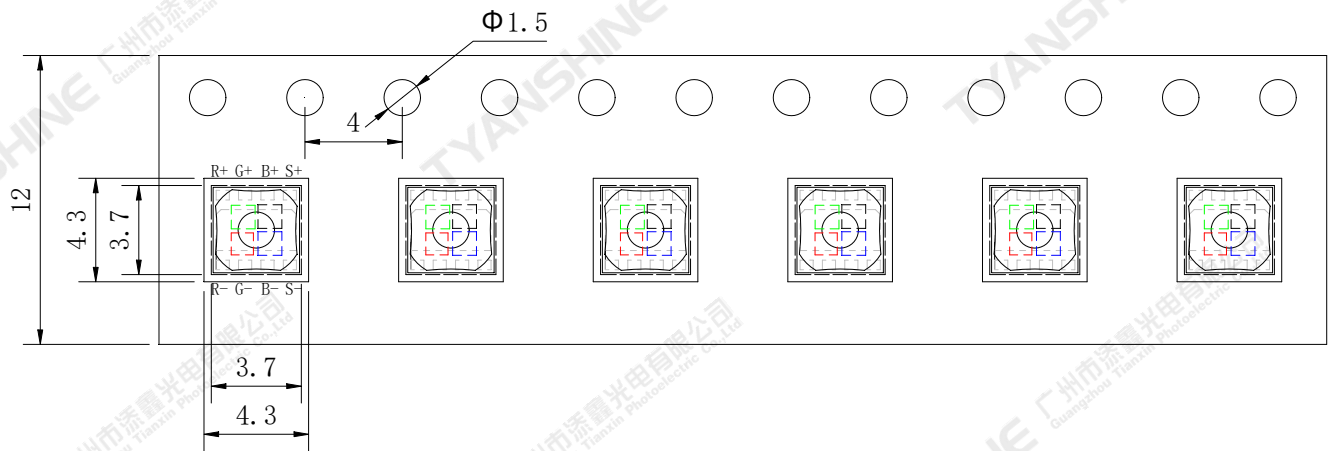

**Notes:**

1. All dimensions are in millimeters.
2. Tolerances are  $\pm 2.0$  mm unless otherwise noted.
3. The products are packaged together with silica gel, Transport, not to the weight of welding LED light-emitting area, As a result of the weight of LED light-emitting zone in the quality of, Irresponsible of the Company.

Part No.	TX-3535RGBW10VSD1-NG4DC-01	Spec No.	WKF-ED0148	Page	9 of 9
----------	----------------------------	----------	------------	------	--------